

Programmable absolute encoder display

Manual ADP-001 Art-Nr.: 485-00220

Edition-/Rev.-Date: 23.05.2000
Document-/Rev.-Nr.: TR - E - BA - GB - 0017 - 00
Firmware version: -
Filename: TR-E-BA-GB-0017.DOC
Author: MÜJ

TR - Electronic GmbH
Eglshalde 6
D-78647 Trossingen

Telefon 07425 / 228-0
Telefax 07425 / 228-33



TR-Electronic GmbH

D-78647 Trossingen

Eglshalde 6

Tel.: (0049) 07425/228-0

Fax: (0049) 07425/228-33

© Copyright 1999 TR-Electronic

Warranty

For delivered products our "Allgemeine Lieferungs- und Zahlungsbedingungen" are effective. In no event TR-Electronic or its suppliers shall be liable for any other damages whatsoever (including, without limitation, damages for loss of business profits, business interruption or other pecuniary loss) arising out of or inability to use this product.

All products from TR-Electronic are warranted against defective material and workmanship for a period of one (1) year from date of delivery. If it is necessary to return the product to TR, the sender is responsible for shipping charges, freight, insurance and proper packaging to prevent breakage in transit. TR's warranty does not apply to defects resulting from action of the buyer, such mishandling, improper interfacing, operation outside of design limits, improper repair or unauthorized modification.

Trademarks

All trademarks that are named or portrayed in the text are registered trademarks of its owner. The trademarks are recognized by TR-Electronic.

CONTENTS

1. Description	4
2. Safety instructions	5
2.1. Symbol explanation	5
3. Mounting	6
3.1. Place of operation	6
3.2. Mounting of signal converter	6
4. Electrical connections	7
4.1. General instructions	7
4.2. Hints against noisy environment	7
4.3. Connection and pin assignment	8
4.4. Connection of absolute encoder	9
4.5. Connection of digital user inputs	9
4.6. Connection of alarm outputs (relay)	9
4.7. Connection of analog output	10
4.8. Connection of power supply voltage	10
4.8.1. Supply voltage 18 ... 36 V DC	10
5. Startup procedure	10
6. Pushbuttons- and LED-functions	11
6.1. Function of buttons and LEDs	11
7. Modes	12
7.1. Operation level	12
7.2. Access-code level	13
7.3. Programming level	14
8. Procedure of programming	15
8.1. Changing or controlling parameters	15
8.2. Overview of the programming levels	16
8.3. Programming level for configuration P-00	17
8.3.1. Scaling the display range	19
8.4. Programming level of alarms P-02	20
8.4.1. Alarm output functions	21

8.4.2.	Alarm high setpoint	22
8.4.3.	Alarm low setpoint	22
8.5.	Programming level for analog output P-03	23
8.5.1.	Scaling of the analog output	23
8.5.2.	Analog output at failure Indication	23
8.5.3.	Analog output at overflow resp. underflow	24
8.6.	Programming quick reference	25
9.	Software functions	27
9.1.	Master/Slave-Mode	27
9.2.	Zero point adjustment	27
9.2.1.	Zero point adjustment by pressing button	27
9.2.2.	Zero point adjustment by offset value	28
9.3.	Incremental measurement	29
9.4.	Direction of rotation	29
9.5.	MIN/MAX value detection	29
9.6.	Hold function	30
9.7.	Display test	30
9.8.	Main reset	31
10.	Error codes	31
10.1.	Encoder not connected "Err01"	31
10.2.	Waiting for data input "Err02"	31
10.3.	External clock frequency too high "ERR03"	31
11.	Technical Specifications	32
11.1.	Electrical datas	32
11.2.	Mechanical datas	32
11.3.	Environmental conditions	33

1. Description

The programmable absolute encoder display ADP-001 is an instrument to convert data of absolute encoders with **Synchronous-Serial-Interface (SSI)** in an analog output signal. Simultaneously, it can carry out an alarm point controlling.

Standard hardware

- isolated analog output 0 - 10 V, 2 - 10 V, 0 - 20 mA, 4 - 20 mA
- two relay alarm outputs
- two programmable digital input channels
- three programmable pushbuttons

Standard software

- Programming of encoder data
- Scaling-factor
- Zero point adjustment
- Offset value
- Display segment test
- Hold function
- MAX/MIN value detection
- Auto-Reset of MAX/MIN value
- Edit of the alarm value during normal measurement
- Display of error messages

2. Safety instructions

This instrument is produced in accordance with Class II of IEC 348 and VDE 0411. When delivered the instrument has been tested to meet all functions described. Before installing the instrument please read the mounting and servicing instructions. We have no liability or responsibility to customer or any other person or entity with respect to any liability, loss or damage caused or alleged to be caused directly or indirectly by equipment or software sold or furnished by us. Read the installation instruction carefully. No liability will be assumed for any damage caused by improper installation.

Inspect the instrument module carton for obvious damage. Be shure there are no shipping and handing damages on the module before processing. Do not apply power to the instrument if it has been damaged.

TR's warranty does not apply to defects resulting from action of the buyer, such as mishandling, improper interfacing, operation outside of design limits, improper repair or unauthorized modifications.

2.1. Symbol explanation



Caution



Attention



Instruction



Tip

Caution: Will be used at **dangerous for life and health !**

Attention: Will cause **damage**

Instruction: If not noticed, **trouble** may occur

Tip: Useful hints for **better operation**

3. Mounting

3.1. Place of operation

Attention must be paid to the protection against humidity, dust and high temperatures at the place of operation.

3.2. Mounting of signal converter

- through simple snap up at 35 mm rail (DIN EN 50022)

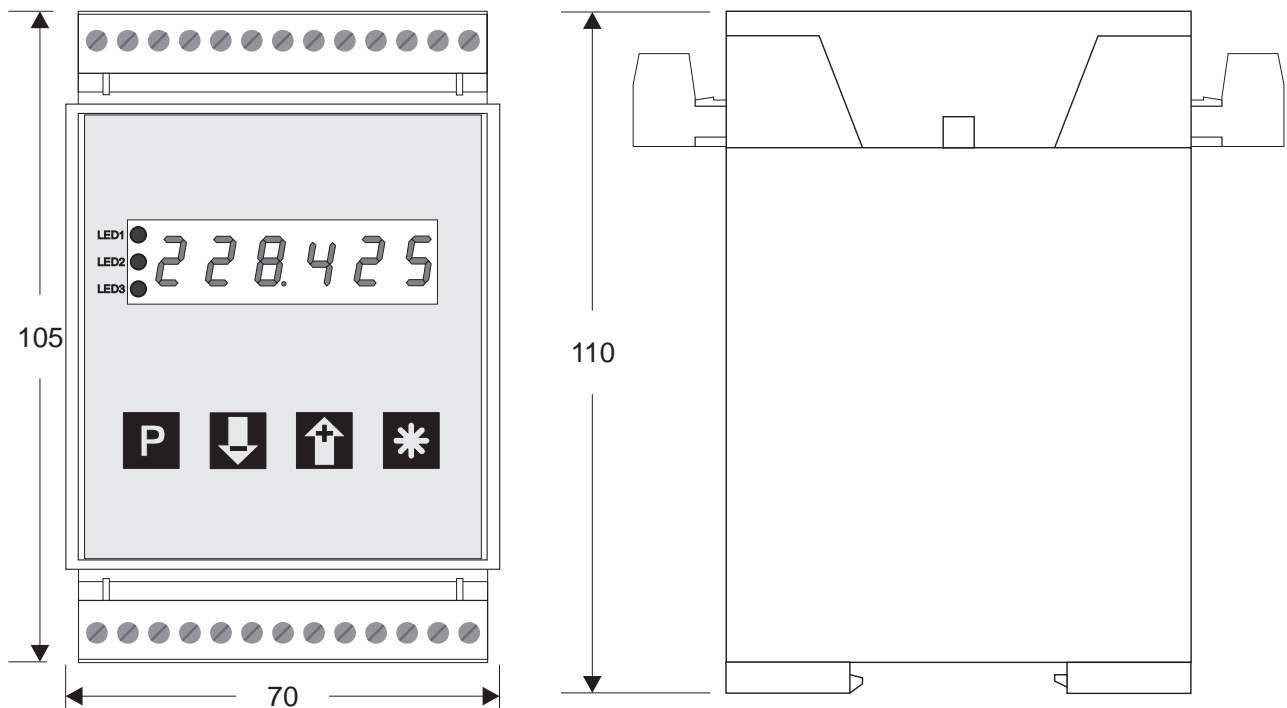

4. **Electrical connections**

4.1. **General instructions**



- It is forbidden to plug or unplug connectors with voltage applied
- Attach input and output wires to the connectors only without voltages applied
- Cords must be provided with sleeves
- Attention must be paid that the power supply voltage applied will agree with voltage noticed at the name plate.
- The instrument has no power-on switch, so it will be in operation as soon as the power is connected.

4.2. **Hints against noisy environment**

All inputs and outputs are protected against noisy environment and high voltage spikes. Nevertheless the location should be selected to ensure that no capacitive or inductive interference can have an effect on the instrument or the connection lines.

It is advisable:



- To use shielded cables.
- The wiring of shields and ground (0V) should be star-shaped.
- The distance to interference sources should be as long as possible. If necessary, protective screen or metal enclosures must be provided.
- Coils of relays must be supplied with filters.
- Parallel wiring of input signals and AC power lines should be avoided.

4. Electrical connections

4.3. Connection and pin assignment

All inputs and outputs are connectors, designed as plug-in screw terminals.



Pin assignment:

1	Power supply DC (+)	14	SSI-Signalinput, Clock (+)
2	Power supply DC (-)	15	SSI-Signalinput, Clock (-)
3	Ground connection	16	SSI-Signalinput, Data (+)
4	Analog output 0/2-10 V (+)	17	SSI-Signalinput, Data (-)
5	Analog output 0/4-20 mA (+)	18	SSI-Signalinput, GND (0 V)
6	Analog output, GND (-)	19	Ground connection
10/11	Alarm (relay) output 1	24	Digital user input 1
12/13	Alarm (relay) output 2	25	Digital user input 2
		26	Digital GND

4.4. Connection of absolute encoder

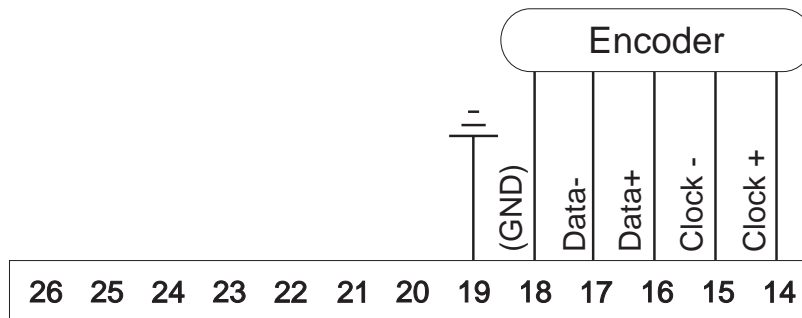

4.5. Connection of digital user inputs

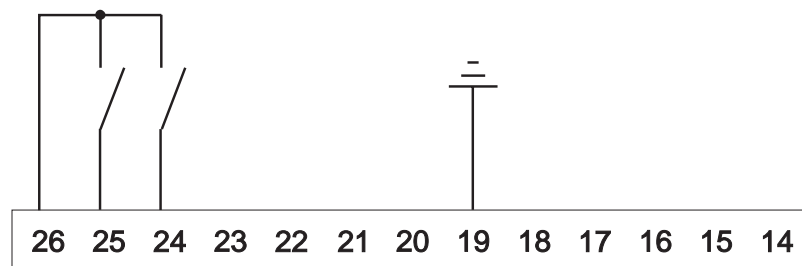

Digital input 1

- active => Connecting Screw Terminal 24 to 26
- Connecting to Ground, low active

Digital input 2

- active => Connecting Screw Terminal 25 to 26
- Connecting to Ground, low-active

4.6. Connection of alarm outputs (relay)

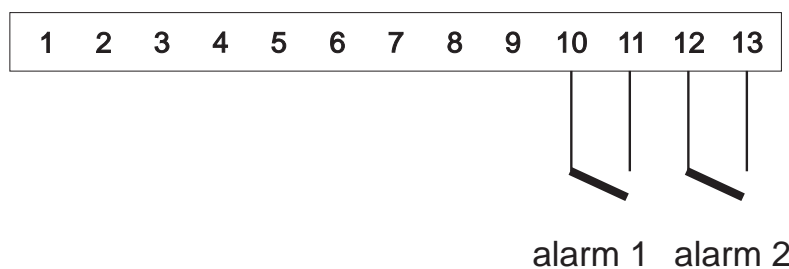

4.7. Connection of analog output

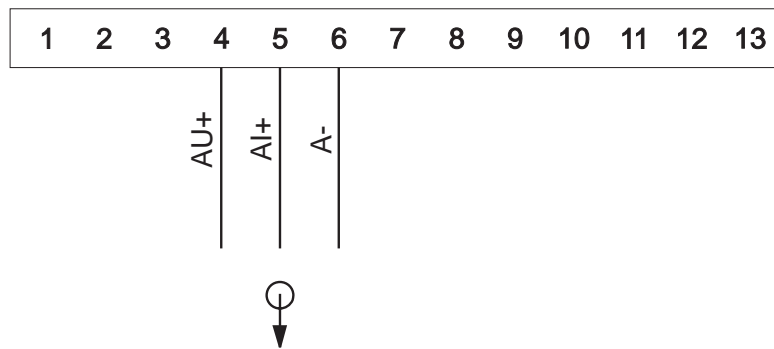

4.8. Connection of power supply voltage

4.8.1. Supply voltage 18 ... 36 V DC

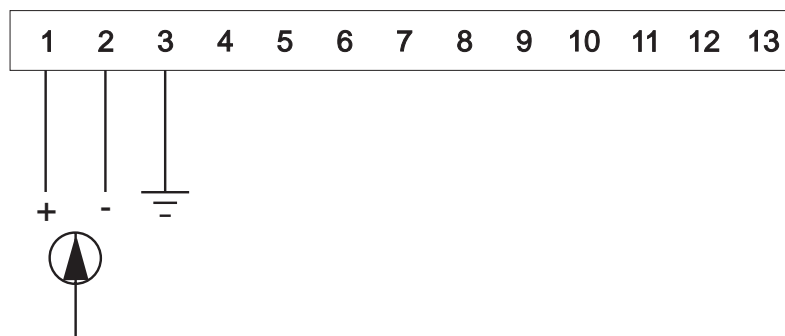

5. Startup procedure

Attention must be paid that the power supply voltage applied will agree with the voltage noticed at the name plate. Switch the power supply on (supply voltage applied to screw terminal 1 and 2). After about 2 seconds the display will indicate the applied input signal.



When delivered, the instrument is programmed with a standard configuration (default values). By programming the customer can change the standard configuration according to his measuring task.



Attention ! When the instrument is built in a machine and the customer wants to change the configuration, attention must be paid, that no damage will occur to the machine!

6. Pushbuttons- and LED-functions

There are four push buttons in the front. These push buttons can have different functions. The functions of the push buttons can be used for programming and for service.

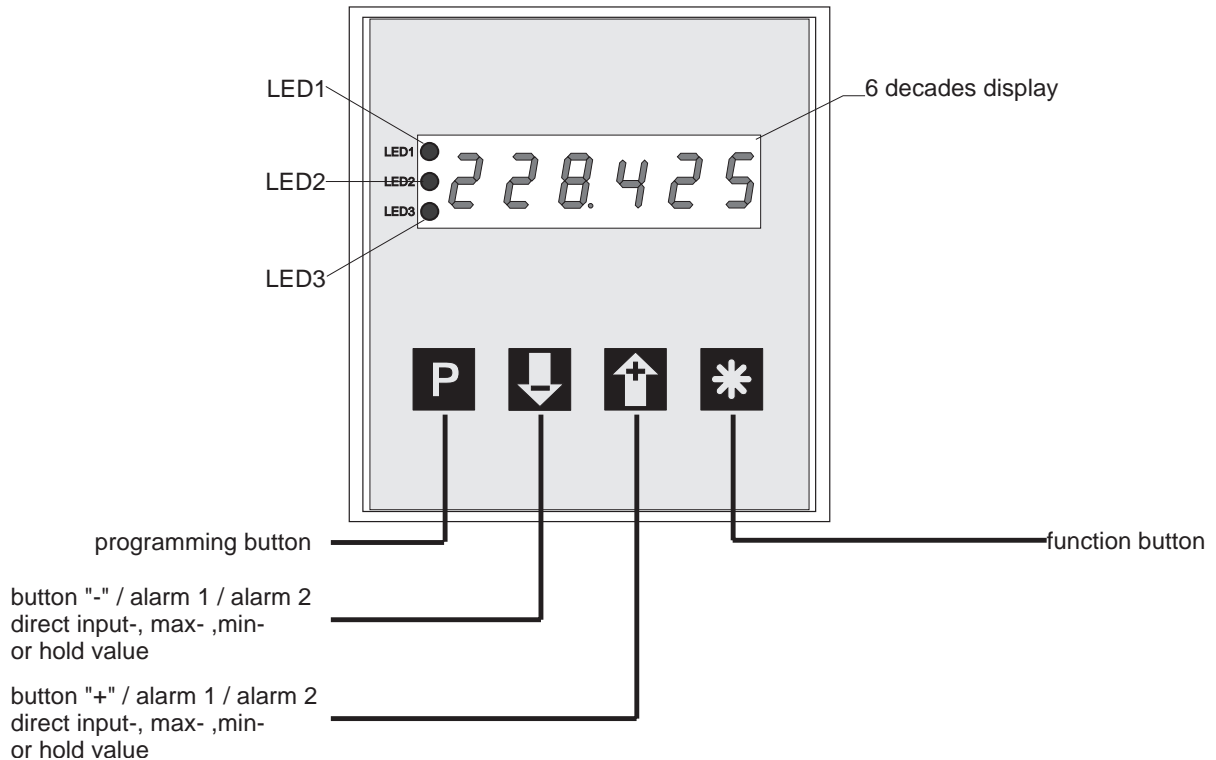

6.1. Function of buttons and LEDs

LED 1	LED 2	LED 3	Description
x	x	off	encoder- or hold value is displayed
x	x	red	MIN value is displayed
x	x	green	MAX value is displayed
x	x	green/flashes	programming mode is activated
x	off	x	alarm 2 is not activated
x	lights	x	alarm 2 is activated
x	flashes	off	alarm point 2 is displayed
x	flashes	green/flashes	alarm point 2 is changed
off	x	x	alarm 1 is not activated
lights	x	x	alarm 1 is activated
flashes	x	off	alarm point 1 is displayed
flashes	x	green/flashes	alarm point 1 is changed

x = state of the LED is not considered

7. Modes



The operation and the programming of the panel meter is organized in several states:

- Operation level
- Access-code level
- Programm level

7.1. Operation level

In the state “operation level” the normal functions of the instrument are activated. A normal measurement cycle looks like below:

- Read the value of encoder, calculate and display
- Evaluate the digital inputs
- Alarm outputs
- Analog output

Dependent on the programming of the parameter **0-14** (function of key ) , **0-15** (function of key ) and **0-13** (function of key ) , following key-functions are available in the operation level.

Parameter 0-13 Function of pushbutton “*”	 By pressing
0	No function
1	Reset the MIN/MAX value
2	Taring
3	Clear tara value
4	Incremental measurement
5	Manual reset of alarms





Parameter 0-14 Function of pushbutton “-”		
	By pressing	Pressing during 3 sec.
0	No function	-
1	Display value of encoder	-
2	Display MAX value	-
3	Display MIN value	-
4	Display hold value	-
5	Display alarm point 1	Change alarm point 1
6	Display alarm point 2	Change alarm point 2

7. Modes

Parameter 0-15 Function of pushbutton “+”		
	By pressing	Pressing during 3 sec.
0	No function	-
1	Display value of encoder	-
2	Display MAX value	-
3	Display MIN value	-
4	Display hold value	-
5	Display alarm point 1	Change alarm point 1
6	Display alarm point 2	Change alarm point 2

7.2. Access-code level





The state “access-code level” becomes active by pressing the pushbutton  during the state “operation level”. The display shows “c000”. During the state “access-code level” the normal functions of the instrument are active.

pushbutton	Function
	Confirm of the displayed access-code
	Increase the access-code
	Decrease the access-code
	Programmed function

7.3. Programming level

The state “programm level” becomes active by entering the right access-code. The access-code must be confirm by pressing the pushbutton . The programming is organized in following steps:



- Selection of a programming level
- Selection of a parameter
- Change of the selected parameter

Pushbutton	Press	Pressing during 3 sec.
	Selection of - Programming level - Parameter	-
	Decrease of - Programming level - Number of parameter - Value of parameter	-
	Increase of - Programming level - Number of parameter - Value of parameter	-
	-	Break the programming routine

8. Procedure of programming

The procedure of programming is organized in several different steps.



Access to the selection of the programming levels

- Pressing pushbutton **P** => access-code enter is active
- The display shows "c000"
- Changing the access-code by pressing the pushbutton  or  and confirm the changed access-code by pressing the pushbutton **P**



If the entered access-code is not correct, the instrument will jump back to the state "operation level".

8.1. Changing or controlling parameters



Activating the programming routine

- Pressing pushbutton **P**
- LED 3 flashes green
- The display shows "c000"
- Changing the access-code by pressing the pushbutton  or 
- Confirm access-code by pressing the pushbutton **P**
- The display shows "P-00"



Leaving the programming routine

- Pressing the pushbutton  or  until the display shows "PEnd"
- Confirm the display "PEnd" by pressing the pushbutton **P**
- LED 3 is off
- The active state of the panel meter is "operation level"



Selection of the programming level

- Selecting the programming level by pressing the pushbutton  or 
- Confirm the programming level by pressing the pushbutton **P**
- The display shows the number of the parameter of the selected programming level
For example: "0-00" => parameter 0 of the programming level 0
For example: "2-00" => parameter 0 of the programming level 2



Leaving the programming level

- Pressing the pushbutton  or  until the display shows "xEnd"
For example: "0End" => leaving programming level 0
For example: "2End" => leaving programming level 2
- Confirm the display "xEnd" by pressing the pushbutton 
- The display shows the programming level
For example: "P-00" => for programming level 0
For example: "P-02" => for programming level 2

Selection of the parameter

- Selection the parameter by pressing the pushbutton  or 
- Confirm the parameter by pressing the pushbutton 
- The display shows the last programmed value of the selected parameter

Change and controll the selected parameter

- Change the value of the parameter by pressing the pushbutton  or 
- Confirm the value of the parameter by pressing the pushbutton 
- The display shows the programming level and the number of the parameter
For example: "0-05" => parameter number 5 of programming level 0
For example: "2-08" => parameter number 8 of programming level 2

8.2. Overview of the programming levels

The parameters of the panel meter are organized in different programming levels.

P-00: Programming level for configuration of the panel meter

The configuration is used to adapt the absolute encoder and the panel meter.

P-02: Programming level for the alarms

This programming level is used to programm all settings for the alarm outputs.

P-03: Programming level for the analog output

This programming level is used to programm all settings of the analog output.

8.3. Programming level for configuration P-00

Param.	Description	Setting range	Default value
0-00	Resolution (Bits)	10 .. 25	12
0-01	Output code 0 -> Gray 1 -> Binary	0 .. 1	0
0-02	Master/Slave-Mode 0 -> Instrument = Master 1 -> Instrument = Slave	0 .. 1	0
0-03	Clock for Master-Mode 0 -> Frequency = 200 kHz 1 -> Frequency = 100 kHz	0 .. 1	0
0-04	Zero adjustment 0 -> Zero adjustment without sign 1 -> Zero adjustment with \pm display	0 .. 1	0
0-05	Counting direction 0 -> increasing clockwise rotation 1 -> increasing anticlockwise rotation	0 .. 1	0
0-06	Scalingfactor	0.00001 .. 9.99999	1.00000
0-07	Offset value	-99999 .. 999999	0
0-08	Programmable decimal points 0 -> XXXXXX 1 -> XXXXX.X 2 -> XXXX.XX 3 -> XXX.XXX 4 -> XX.XXXX 5 -> X.XXXXX	0 .. 5	0
0-09	Data source of the display 0 -> Encoder value 1 -> MAX value 2 -> MIN value 3 -> Hold value	0 .. 3	0
0-10	Reset time of the MIN/MAX value 0 -> No automatically reset X -> Reset time in seconds	0 .. 100	0
0-11	Function of digital user input 1 0 -> No function 1 -> Reset MIN/MAX value 2 -> Taring of encoder 3 -> Clear tara value of encoder 4 -> Incremental measurement	0 .. 10	0

8. Procedure of programming

0-11	continue of 0-11: Function of digital input 1 5 -> Manual reset of alarms 6 -> Hold function 7 -> Display test 8 -> Display value of encoder 9 -> Display MAX value 10 -> Display MIN value	0 .. 10	0
0-12	Function of digital user input 2 0 -> No function 1 -> Reset MIN/MAX value 2 -> Taring of encoder 3 -> Clear tara value of encoder 4 -> Incremental measurement 5 -> Manual reset of alarms 6 -> Hold function 7 -> Display test 8 -> Display value of encoder 9 -> Display MAX value 10 -> Display MIN value	0 .. 10	0
0-13	Function of push button "*" 0 -> No function 1 -> Reset MIN/MAX value 2 -> Taring of encoder 3 -> Clear tara value of encoder 4 -> Incremental measurement 5 -> Manual reset of alarm	0 .. 5	0
0-14	Function of pushbutton "-" 0 -> No function 1 -> Display value of encoder 2 -> Display MAX value 3 -> Display MIN value 4 -> Display hold value 5 -> Display/change alarm point 1 6 -> Display/change alarm point 2	0 .. 6	0
0-15	Function of pushbutton "+" 0 -> No function 1 -> Display value of encoder 2 -> Display MAX value 3 -> Display MIN value 4 -> Display hold value 5 -> Display/change alarm point 1 6 -> Display/change alarm point 2	0 .. 6	0
0-19	Access-code	0 .. 999	0
0End	Leaving programming level 0		

8.3.1. Scaling the display range

The scaling of the display range is matched by using a scaling-factor and an offset value. The calculation of the display value looks like below:

$$\text{Display} = (\text{Enc_value} - \text{Zero_adjustmet}) \times \text{Sca_faktor} + \text{Offset value}$$

The overflow or underflow becomes active, if the displayed value is greater than 999999 or smaller than -99999.

- When **overflow** is activ the display shows “nnnnnn”
- When **underflow** is active the display shows “uuuuuu”

8.4. Programming level of alarms P-02

Param.	Description	Setting range	Default value
2-00	Alarm output 1, data source 0 -> Alarm 1 off 1 -> Alarm 1 to value of encoder 2 -> Alarm 1 to maximum value 3 -> Alarm 1 to minimum value 4 -> Alarm 1 to hold value	0 .. 4	0
2-01	Alarm output 1, high or low 0 -> Contact closed by low limit 1 -> Contact closed by high limit 2 -> Contact open by low limit 3 -> Contact open by high limit	0 .. 3	0
2-02	Alarm output 1, alarm point	-99999 .. 999999	0
2-03	Alarm output 1, hysteresis	1 .. 1000	1
2-04	Alarm output 1, release delay time in seconds	0 .. 60	0
2-05	Alarm output 1, operate delay time in seconds	0 .. 60	0
2-06	Alarm output 2, data source 0 -> Alarm 2, off 1 -> Alarm 2 to value of encoder 2 -> Alarm 2 to maximum value 3 -> Alarm 2 to minimum value 4 -> Alarm 2 to hold value	0 .. 4	0
2-07	Alarm output 2, high or low 0 -> Contact closed by low limit 1 -> Contact closed by high limit 2 -> Contact open by low limit 3 -> Contact open by high limit	0 .. 3	0
2-08	Alarm output 2, alarm point	-99999 .. 999999	0
2-09	Alarm output 2, hysteresis	1 .. 1000	1
2-10	Alarm output 2, release delay time in seconds	0 .. 60	0
2-11	Alarm output 2, operate delay time in seconds	0 .. 60	0
2End	Leave programming level P-02		

8.4.1. Alarm output functions

Data sources of the alarms:

- Value of the encoder
- Maximum value
- Minimum value
- Hold value

Indication of alarms

- Two relay output
- LED 1 and LED 2 at the front



Programmable functions of the alarms

- Alarm value
- Hysteresis
- Release delay time and operate delay time
- High or low alarm

Manual alarm reset

In dependence of programming the digital inputs and the functional pushbutton  is the alarm output latched or not latched.



Alarm output latched:

- If the digital input 1, 2 (parameter 0-11 and 0-12) or the functional pushbutton  (parameter 0-13) is programmed to manual alarm reset
- Reset the latched alarm output by activate the digital inputs or press the functional pushbutton 

Alarm output not latched:

- If the digital inputs and the functional pushbutton  are not programmed to manual alarm reset

Display and edit the alarm values

- Inside the programmig routine, which is reached over the enter code. During the programming routine no measurement is taken.
- Outside the programming routine by pressing the pushbutton  or  during normal measurement are taken.

The edition is end when pressing the pushbutton  . Therefore the alarm value will be up to date.

8.4.2. Alarm high setpoint

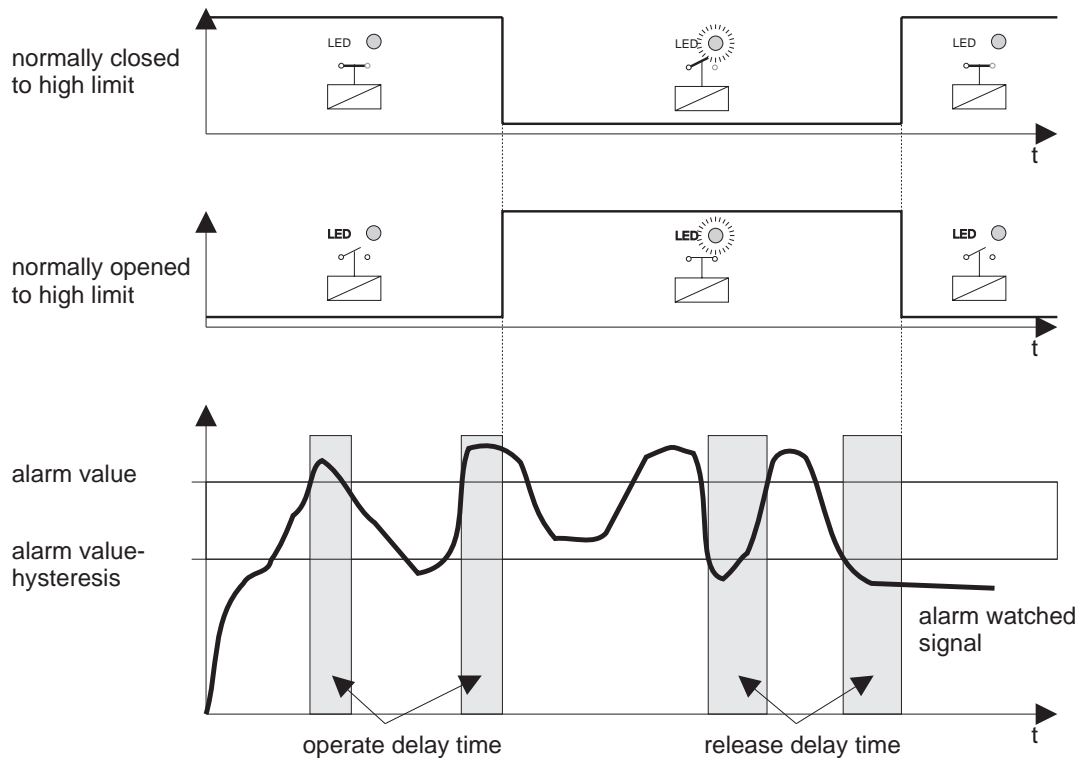

8.4.3. Alarm low setpoint

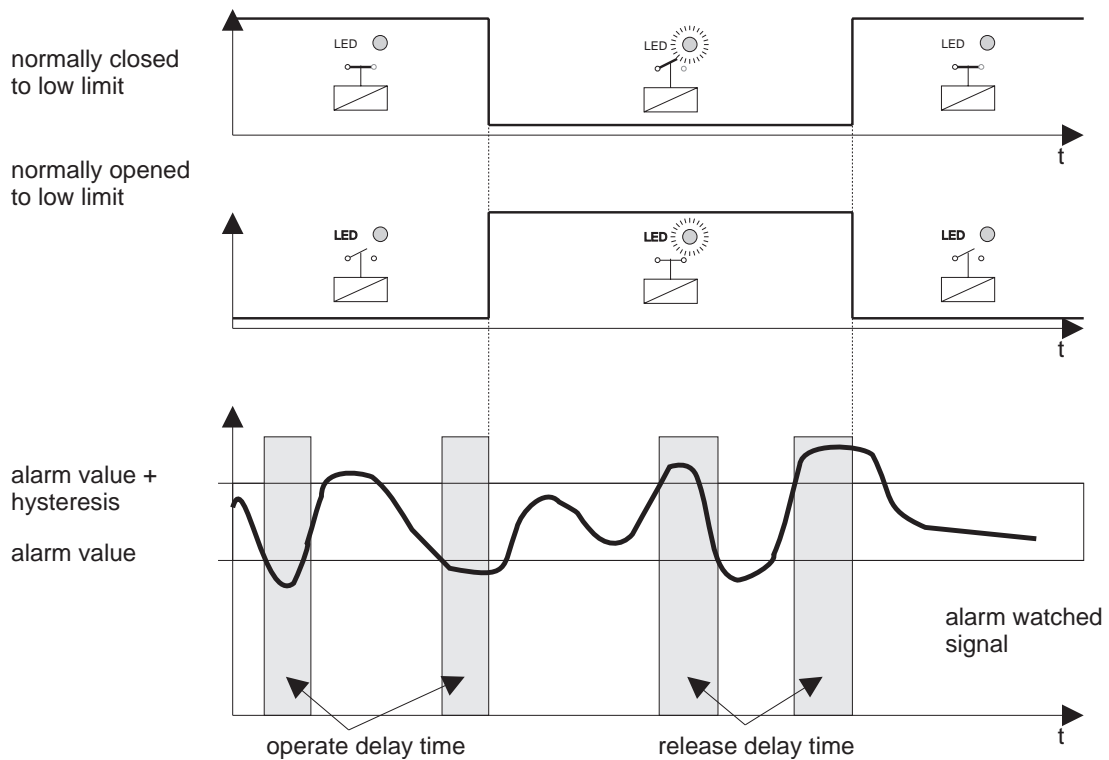

8.5. Programming level for analog output P-03

Param.	Description	Seeting range	Default value
3-00	Analog Output, data source 0 -> Value of encoder to analog output 1 -> MAX value to analog output 2 -> MIN value to analog output 3 -> Hold value to analog output	0 .. 3	0
3-01	Analog Output, configuration 0 -> 0 to 10 V 1 -> 2 to 10 V 2 -> 0 to 20 mA 3 -> 4 to 20 mA	0 .. 3	0
3-02	Display value for minimal analog output signal	-99999 .. 999999	0
3-03	Display value for maximal analog output signal	-99999 .. 999999	4095
3End	Leave programming level P-03		

8.5.1. Scaling of the analog output

The scaling of the analog output range can be programmed with the parameter 3-02 and 3-03. Any value between -99999 and 999999 can be set to minimal and maximal analog output signal.

Data sources of the analog output:

- Value of encoder
- Maximum value
- Minimum value
- Hold value

8.5.2. Analog output at failure Indication

Output signal	Output value by "Err01"	Output value by "Err02" and "Err03"
Voltage 0 to 10 V	0 V	current value won't be changed
Voltage 2 to 10 V	1 V	
Current 0 to 20 mA	0 mA	
Current 4 to 20 mA	2 mA	

8.5.3. Analog output at overflow resp. underflow

Output signal	Output value by overflow	Output value by underflow
Voltage 0 to 10 V	10 V	0 V
Voltage 2 to 10 V	10 V	2 V
Current 0 to 20 mA	20 mA	0 mA
Current 4 to 20 mA	20 mA	4 mA

8. Procedure of programming

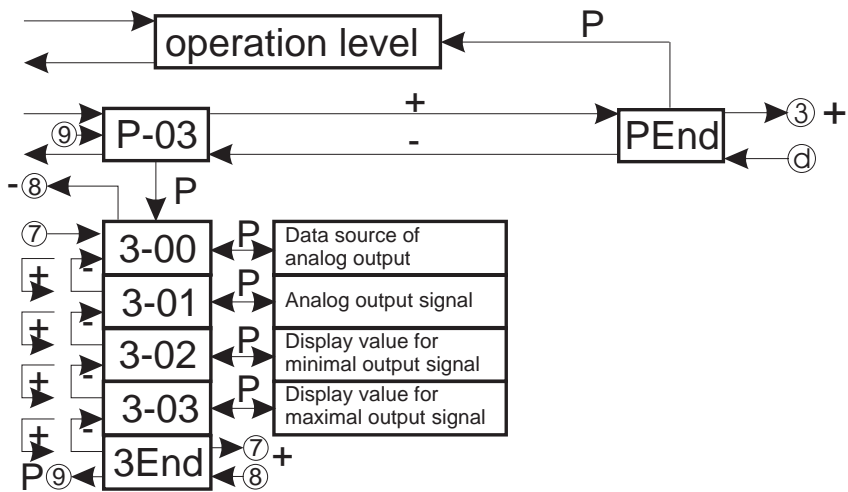

description	
P →	pressing the button P
+ →	pressing the button ↑
- →	pressing the button ↓

9. Software functions

9.1. Master/Slave-Mode

Master-Mode

Parameter 0-02 have to be programmed to 0

For reading the value of the encoder the clock is generated by the instrument. The clock frequency can be programmed to 100 kHz or 200 kHz. (parameter 0-03)

Slave-Mode:

Parameter 0-02 have to be programmed to 1

The clock signal have to be generated by an other instrument. The data transmission between the encoder and the instrument dependent on this "external clock".

In slave mode attention should be paid to:



- External clock may not exceed 125 kHz
- Pause of clock brushes have to be min. 500 μ s
- The encoder value will be displayed with 28 values per second

9.2. Zero point adjustment

Sometimes an exactly mechanical zero point adjustment isn't possible. But it's possible to adjust the zero point by software.

9.2.1. Zero point adjustment by pressing button

The zero point can be changed by pressing the  button. Parameter 0-13 have to be programmed to 2.

1. Zero point adjustment with sign:

Parameter 0-04 have to be programmed to 1

Example:

Absolute Encoder SSI-Encoder, singeltur'n
Resolution: 4096 steps per rotation

Display range without changing of the zero point

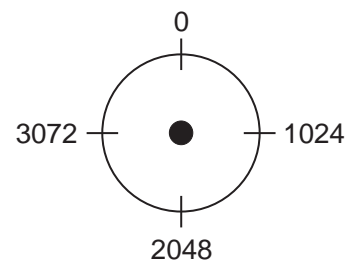

Display range with changing of the zero point

The pushbutton  have been pressed by a display of 2048

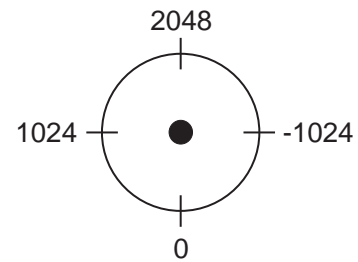

2. Zero point adjustment without sign:

Parameter 0-04 have to be programmed to 0

Example:

Absolute Encoder SSI-Encoder, singleturn
Resolution: 4096 steps per rotation

Display range without changing of the zero point

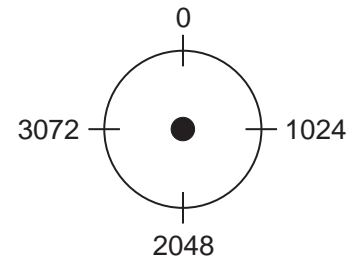

Display range with changing of the zero point

The pushbutton  have been pressed by a display of 2048

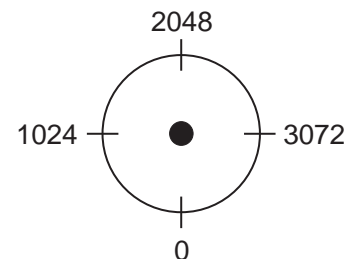

9.2.2. Zero point adjustment by offset value

The calculation of the programmed offset value (parameter 0-07) looks like below:

$$\text{Display} = (\text{Enc_value} - \text{Zero_adjustmet}) \times \text{Sca_faktor} + \text{Offset value}$$

There can be a \pm display, as a result of programming an offset value.

Attention should be paid to:





- The charging of the offset value is followed **after** the charging of the scaling-factor.
- The Parameter 0-04 have to be programmed to 1

9.3. Incremental measurement

A relative measurement can be made by using the incremental measurement function. Activating the incremental measurement function will happen, that a incremental measurement value will be stored to a non-volatile EEPROM even after switching of the instrument.

Activating the incremental measurement function

- The digital input 1 (parameter 0-11)
- The digital input 2 (parameter 0-12)
- The functional pushbutton  (parameter 0-13)

Activating the incremental measurement function by pressing the functional pushbutton  or activating digital input 1/digital input 2 (dependent on the programming of the parameter 0-11, 0-12 and 0-13), cause that the current encoder value is stored to an EEPROM. This value will be subtracted from each current encoder value.

Activating the function a second time will switch off the function and clear the incremental measurement value of the EEPROM.

9.4. Direction of rotation

The direction of rotation can be changed by software function. The encoder will usually count in increasing direction, if the driving shaft turns with clockwise rotation (top view at the driving shaft).

**Increasing values with clockwise rotation (top view at the driving shaft),
Parameter 0-05 have to be programmed to 0**

**Increasing values with anti-clockwise rotation (top view at the driving shaft),
Parameter 0-05 have to be programmed to 1**



9.5. MIN/MAX value detection

The panel meter include a MIN/MAX value detection. The maximum and minimum value can be displayed with the frontal push buttons or the digital user inputs. Besides the maximum and minimum value can be controlled of the alarm output or can be used as the data source for the analog output

Reset the minimum and maximum values:

- Automatically by the programmed memory reset time (parameter 0-10)
- By activating the digital inputs 1 or 2 (parameter 0-11 and 0-12)
- By pressing the functional pushbutton  (parameter 0-13)
- By leaving the programming routine

Display the minimum and maximum value

- By programming as data source of the display (parameter 0-09)
- By activating the digital input 1 or 2 (parameter 0-11 and 0-12)
- By pressing the pushbutton  or  (parameter 0-15 and 0-14)

Indication of the displayed minimum and maximum value

- LED 3 lights red => minimum value is displayed
- LED 3 lights green => maximum value is displayed

9.6. Hold function

When activating the hold function the value of the data source, which is programmed in parameter 0-09, is taken over into the hold memory. If the hold function is not active the hold value is the same as the value of the data source, which is programmed in parameter 0-09.



Activating the hold function by:

- Digital input 1 (parameter 0-11)
- Digital input 2 (parameter 0-12)

Reset the hold value

- By leaving the programming routine

Display the hold value by

- Programming as data source of the display (parameter 0-09)
- Pressing the pushbutton  or  (parameter 0-15 and 0-14)

The hold value can:

- Show on display
- Watched by alarm output
- Set to the analog output

9.7. Display test

When activating the display test all segments of the display are light on. The display shows "8.8.8.8.8.8."

Activating the display test by:

- Digital input 1 (parameter 0-11)
- Digital input 2 (parameter 0-12)

9.8. Main reset

The main reset is performed by pressing a key combination at the front of the panel meter. By doing this all parameters are setting to the default value. The value of the parameter 0-00 (input range) is not changing by the main reset.

During the main reset the display shows "Init."

Perform the main reset by

Pressing the pushbuttons  ,  and  at the same time during 10 seconds.

10. Error codes

10.1. Encoder not connected "Err01"

- The display flashes and indicate "Err01"
- Signalizes that no encoder have been connected to the instrument

10.2. Waiting for data input "Err02"

- The display flashes and indicate "Err02"
- Signalizes in slave-mode, that after the connection of an encoder no data input have been received by the instrument.

10.3. External clock frequency too high "ERR03"

- The display flashes and indicate "Err03"
- Signalizes in slave mode, that the clock frequency of the "external clock" is too high (> 125 kHz).

11. Technical Specifications

11.1. Electrical datas

SSI signal input	: singleturn or multiturn
Resolution	: 10 .. 25 bit
Code	: binary or gray
Clock output	: driver RS 422/485
Clock input	: receiver RS 422/485
Data input	: receiver RS 422/485
Master mode	
Clock frequency	: internal, 100 kHz or 200 kHz
Conversion rate	: approximate 28 values/second
Slave mode	
Clock frequency	: external, max. 125 kHz
Break of clock brushes	: min. 500 μ s
Conversion rate	: approximate 28 values/second
Digital user inputs	: 10 k Ω to +5 V
Logic	: NPN, max. 30 V
Signal level	: L-Pegel < 0,4 V : H-Pegel > 3,5 V
Alarm outputs	: 2 relays (programmable as opened contact or closed contact)
Signaling	: 2 LEDs at the front
Switch voltage	: 250 V AC / 250 V DC
Switch current	: 5 A AC / 5 A DC
Switch power	: 750 VA / 100 W
Analog output	: resolution 16 bit
Accuracy	: \pm 0,2 % of final value
Voltage	: 0/2 - 10 V, max. 10 mA
Current	: 0/4 - 20 mA, max. 500 Ω
Isolation voltage	: 3 kV / 1 min
Power supply DC	: 18 .. 36 V DC
Power consumption	: approx. 200 mA
Isolation voltage	: 500 V / 1 min

11.2. Mechanical datas

Display	: 6 decades, 8 mm, red : decimal point programmable : preliminary zero suppression : - sign at negative values
----------------	---

11. Technical Specifications

Operation, keyboard design	: front membrane with push buttons
Case	: rail mounting DIN EN 50022
	: 35 mm snap in
Dimensions (W x H x D)	: 67,5 x 75 x 105 mm
Weight	: approx. 300 g
Connection	: plug-in screw terminal
	: max. \square 2,5 mm ²

11.3. Environmental conditions

Operating temperature	: 0 .. 50 °C
Storage temperature	: -20 .. 70 °C
Humidity	: < 80 %, not-condensing
Protection	: protection class II
Front protection	: IP 40
	: connectors IP 20
Field of application	: class 2
	: overvoltage protection II
CE	: in conform with 89/336/EWG
	: NSR 73/23/EWG