

# LDR2-132IR850-LA/940-LA

Model	LDR2-132IR850-LA/940-LA
Voltage	12V DC
Power consumption	16W
Mass	270g
Connector type	2P (1: +, 2: -)

Third Angle Projection Units: mm

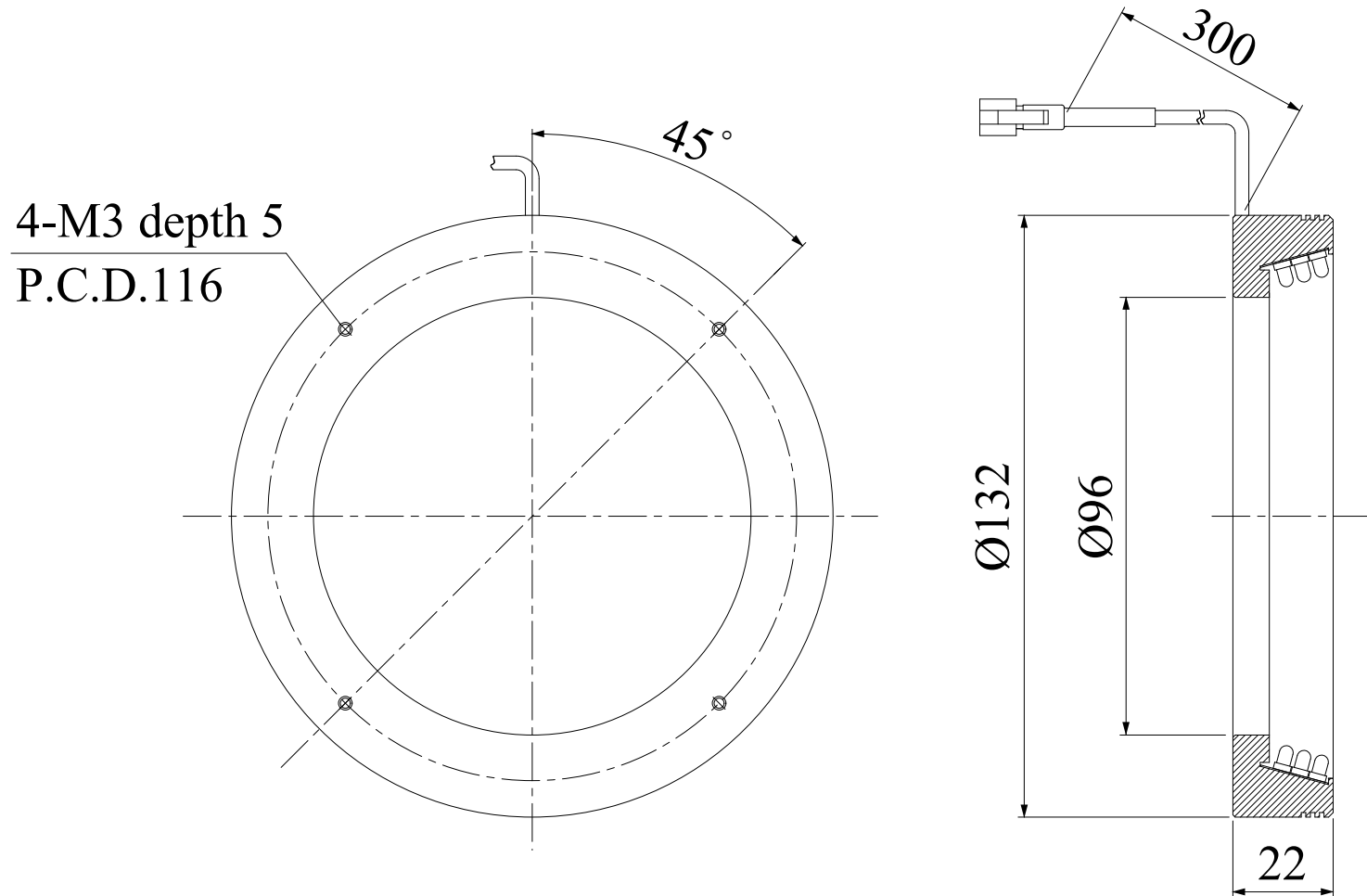



# Infrared Lights IR Series

For imaging by means of the property of higher transmittance than that of visible light  
Suitable for checking the presence of substances, inclusions of foreign matter, and character recognition  
by means of transmittance through varieties of dye inks and solids.

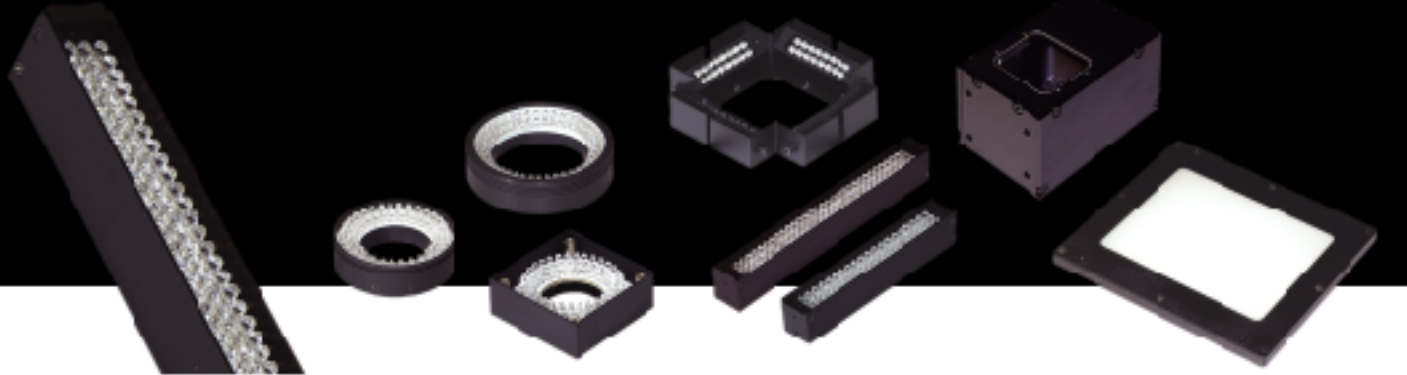

IR Series offers choice of peak wavelengths of 850-nm or 950-nm

### 850-nm versus 940-nm peak wavelength emission spectrum

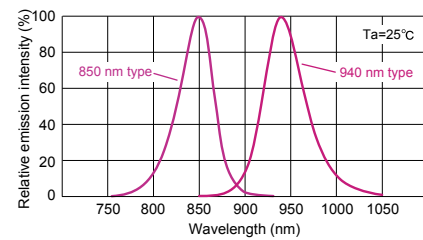

Infrared lighting IR Series are available in the LED peak wavelengths of 850nm and 940nm. A wide product lineup offers optimum lighting solutions best suited to a variety of inspection objects, inspection environments and optical systems.

### Product line for IR

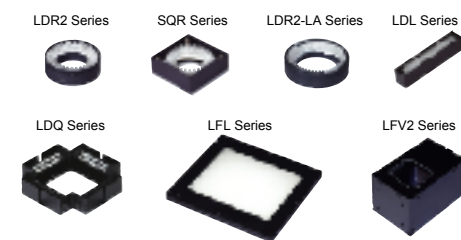

### Imaging with peak wavelength of 850 nm vs. 940 nm

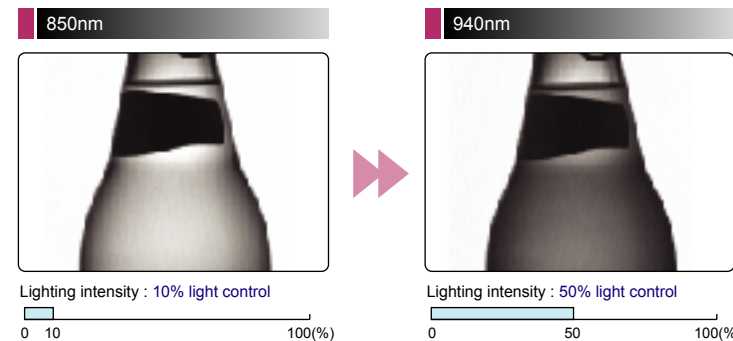

Use a CCD camera sensitive in the near infrared region for use with an infrared light.  
A shot image is affected by the distribution of the emission spectrum of the UV light LED and the spectral sensitivity characteristics of a CCD camera.  
Optimized combination with an optical system is very important for achieving stable images.

### Typical camera\* spectral sensitivity characteristic vs. infrared LED emission spectrum distribution

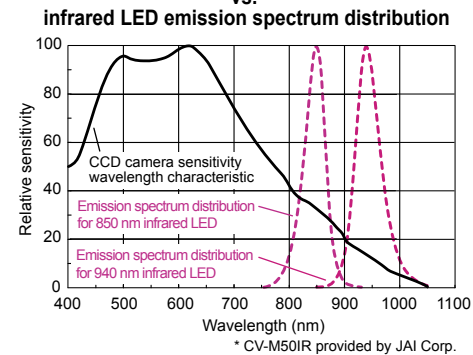

## Product Lineup Table

Series	Model Name	Color	Power Consumption	Options	Dimension
LDR2	LDR2-50IR850□	●	12V/3.8W	—	1
	LDR2-50IR940	●	12V/3.8W	—	1
	LDR2-70IR850□	●	12V/7.6W	—	2□
	LDR2-70IR940	●	12V/7.6W	—	2□
	LDR2-90IR850□	●	12V/14W	—	3
SQR	SQR-56IR850□	●	12V/3.8W	—	4□
	SQR-56IR940	●	12V/3.8W	—	4□
LDR2-LA	LDR2-74IR850-LA□	●	12V/5.7W	—	5□
	LDR2-74IR940-LA	●	12V/5.7W	—	5□
	LDR2-132IR850-LA□	●	12V/16W	—	6
LDL	LDR2-132IR940-LA	●	12V/16W	—	6
	LDL-42x15IR850□	●	12V/1.9W	—	7□
	LDL-42x15IR940	●	12V/1.9W	—	7□
	LDL-74x27IR850□	●	12V/6.9W	—	8
LDL-74x27IR940	●	12V/6.9W	—	8	

Series	Model Name	Color	Power Consumption	Options	Dimension
LDL	LDL-82x15IR850□	●	12V/3.8W	—	9
	LDL-82x15IR940	●	12V/3.8W	—	9
	LDL-130x15IR850□	●	12V/6.1W	—	10□
	LDL-130x15IR940	●	12V/6.1W	—	10□
	LDL-180x16IR850□	●	12V/8.4W	—	11□
LDQ	LDL-180x16IR940	●	12V/8.4W	—	11□
	LDQ-78IR850□	●	12V/6.1W	—	12□
	LDQ-78IR940	●	12V/6.1W	—	12□
LDQ	LDQ-150IR850□	●	12V/16W	—	13□
	LDQ-150IR940	●	12V/16W	—	13□
LDL	LDL-100x100IR850	●	24V/21W	—	14
LFL	LDL-100x100IR940	●	24V/21W	—	14
	LFL-100IR850□	●	12V/5.3W	—	15□
LFV2	LFL-100IR940	●	12V/5.3W	—	15□
	LFV2-50IR850□	●	12V/8.4W	—	16
LFV2-50IR940	●	12V/8.4W	—	16	

## Dimensions (Unit: mm)

## Infrared lighting application examples

### Wafer image

A backlight with visible light does not transmit through wafer.  
Light used: LDL-100x100

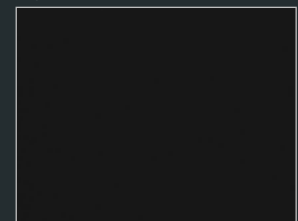

### With occluding graphics

An IR backlight passes through the wafer material to uniformly illuminate the pattern.  
Light used: LDL-100x100IR850

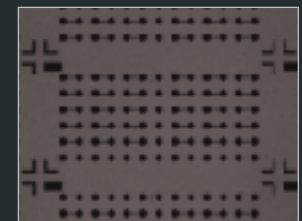

### Visible light of any wavelength illuminates the graphics behind the date.

Visible light of any wavelength illuminates the graphics behind the date.  
Light used: LDL-74x27-SW



### IR light passes through the occluding graphic pigment but not this printed date code enabling reliable OCR/OCV.

IR light passes through the occluding graphic pigment but not this printed date code enabling reliable OCR/OCV.  
Light used: LDL-74x27IR850



## Infrared lighting application examples

### Printed date code occluding molded surface features

Printed text on the cap absorbs visible light causing it to occlude any surface defects or feature detection.  
Light used: LDR2-132SW-LA

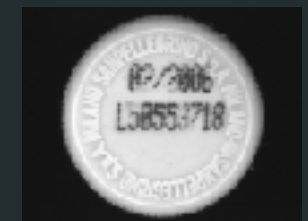

### IR light passes through the printed text and reflect uniformly from the unbroken surface allowing for defect or feature detection.

IR light passes through the printed text and reflect uniformly from the unbroken surface allowing for defect or feature detection.  
Light used: LDR2-132IR940-LA



### Foreign matter mixed in beverage container

A visible light from a backlight does not penetrate the plastic bottle.  
Light used: LFL-100



### An IR backlight penetrates the plastic bottle and silhouettes the foreign object resting at the bottom for reliable detection.

An IR backlight penetrates the plastic bottle and silhouettes the foreign object resting at the bottom for reliable detection.  
Light used: LFL-100IR940

