

QSQ-056056-47/-52/-66/-SW

Model	QSQ-056056-66	QSQ-056056-47/-52/-SW
Voltage	24V DC	24V DC
Power Consumption	3.0 W	4.8 W
Mass	90 g	90 g

Third Angle Projection All dimensions in mm

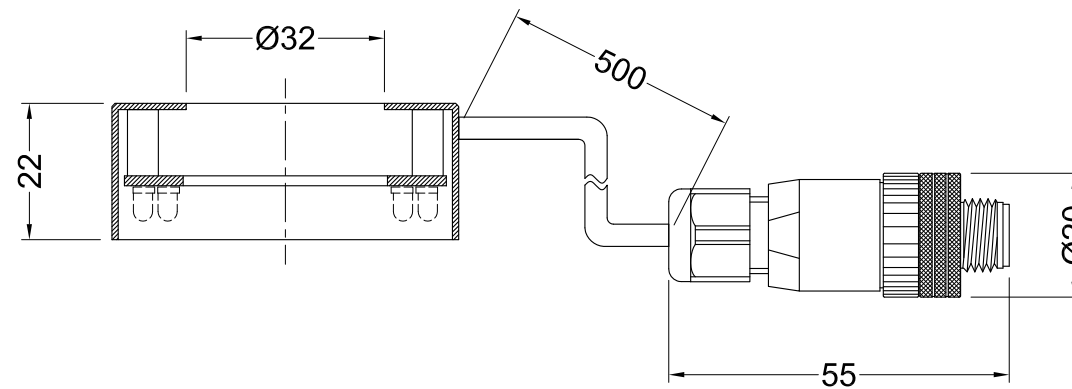
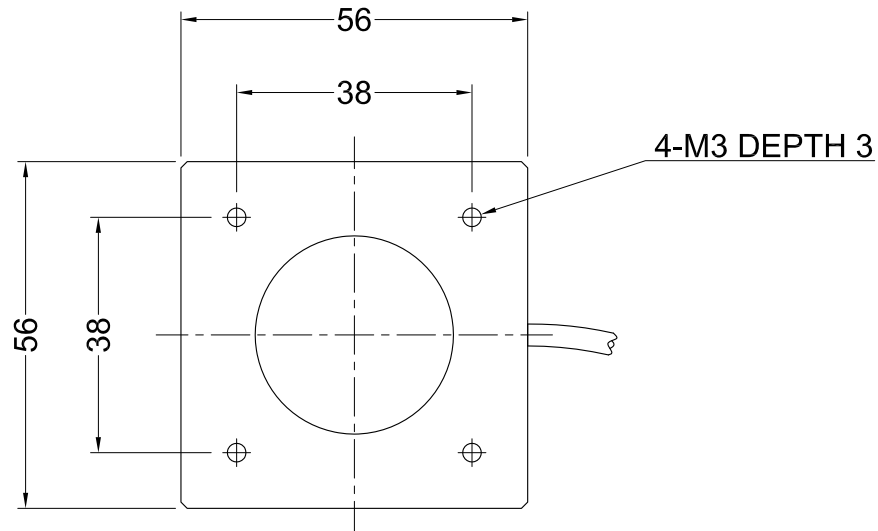

M12 X 1 MALE CONNECTOR

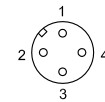

PIN 1: (+): BROWN
 PIN 2: NC
 PIN 3: (-): BLUE
 PIN 4: NC

CABLE THICKNESS 3.6

QL series

Quality, features and pricing
for a new Vision World

- High intensity
- 24 Volt input
- Industry standard rugged connectors and cables
- Compact size
- Value priced

QSQ SQUARE RING LIGHTS

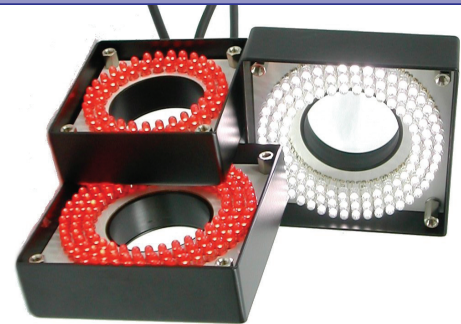

Part number	Color	Power	Weight	Diffuser	Polarizer
QSQ-056056-	66	24V / 3.0W	90 g	DF-QSQ-056056	PL-QSQ-056056
	47/52/SW	24V / 4.8W			
QSQ-070070-	66	24V / 6.0W	130 g	DF-QSQ-070070	PL-QSQ-070070
	47/52/SW/IR95	24V / 9.6W			

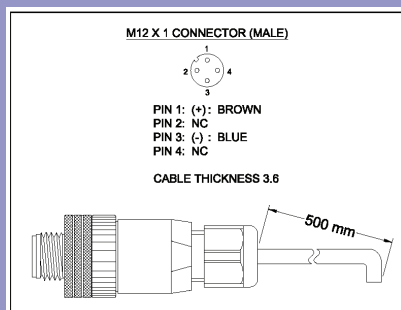

- All QL series lights come standard with a 500mm cable and a quick disconnect M12 connector.
- For connection to **QLC-200-24V** controller or direct to 24VDC power supply (QPS-24V), use QRK-44T-n (n=2,3,5) extension cable.
- For connection to CCS 24V power supplies, use QADC-01 adaptor.

Part number designation

QBR-xxxxyy-zz
xxx : case length in mm
yyy : case height in mm

zz : 66 660 nm Red
47 470 nm Blue
52 525 nm Green
IR95 950 nm Infrared
SW White

QL Series Connections Guide For: QSQ-056056-52

Power Supply Options:

PB-2430	PD2-3024	PDS-30
PSB-524V	PD2-5024	DIL-5000-WV
PSB-3024VB	PD2-3024-2	STU-3000
PSB-1024V-WW	PD2-3024-4	
PD2-1024	PTU2-3024	

- For connection to above listed power supplies, use QADC-01 adaptor cable.
- Extension cables for QSQ-056056-52 light when used with above listed power supplies (QADC-01 adaptor required):

FCB-1	FRCB-5	FCB-F-5
FCB-2	FCB-10	FCB-W-2
FCB-3	FCB-20-1.25SQ	FCB-W-5
FCB-5	FCB-F-2	

24V DC Connection:

- For direct connection to 24V DC regulated power supply, use QRK-44T-n (n=2,3,5) extension cable.

QLC-200-24V – Overdriving Strobe Controller:

- For connection to QLC-200-24V controller or direct to 24VDC (QPS-24DC), use QRK-44T-n (n=2,3,5) extension cable.

Part Numbers		
Extension Cable	Controller	24 V DC Supply
QRK Series	QLC-200-24V	QPS-24DC

Extension Cable Part numbers	
Part Number	Length (m)
QRK-44T-2	2
QRK-44T-3	3
QRK-44T-5	5

