

# QLA-134096-47/-52/-66/-SW

Model	QLA-134096-47/-52/-SW	QLA-134096-66
Voltage	24V DC	24V DC
Power Consumption	20.2 W	12.6 W
Mass	255 g	255 g

Third Angle Projection All dimensions in mm

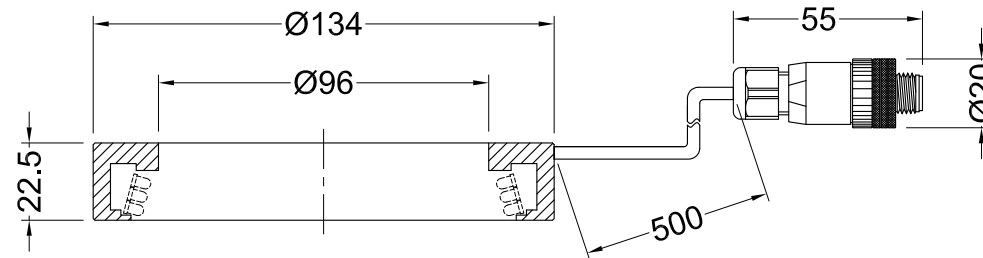
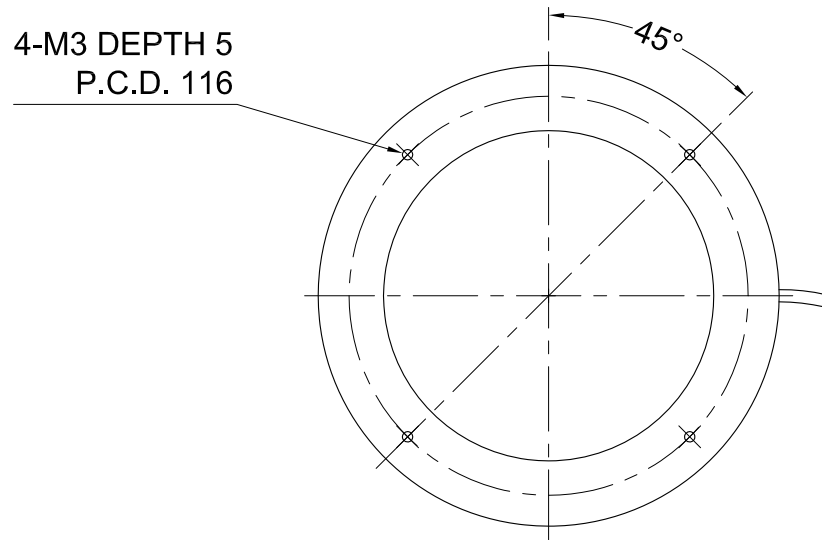

M12 X 1 MALE CONNECTOR

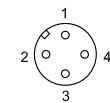

PIN 1: (+): BROWN  
PIN 2: NC  
PIN 3: (-): BLUE  
PIN 4: NC

CABLE THICKNESS 3.6

# QL series

Quality, features and pricing  
for a new Vision World

## QLA LOW ANGLE LIGHTS

- High intensity
- 24 Volt input
- Industry standard rugged connectors and cables
- Compact size
- Value priced



Part number	Color	Power	Weight
QLA-074050-	66	24V / 5.4W	70 g
	IR95	24V / 6.0W	
	47 / 52 / SW	24V / 7.2W	
QLA-134096-	66	24V / 12.6W	255 g
	47 / 52 / SW	24V / 20.2W	
QLA-208172-	66	24V / 21.6W	305 g
	47 / 52 / SW	24V / 27.7W	

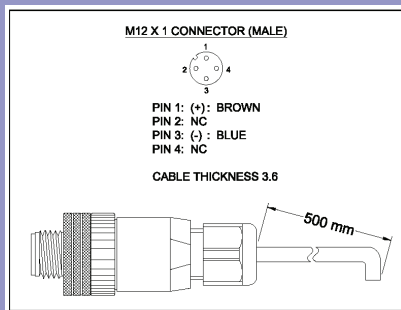

- All QL series lights come standard with a 500mm cable and a quick disconnect M12 connector.
- For connection to **QLC-200-24V** controller or direct to 24VDC power supply (QPS-24V), use QRK-44T-n (n=2,3,5) extension cable.
- For connection to CCS 24V power supplies, use QADC-01 adaptor.

### Part number designation

QBR-xxxxyy-zz  
xxx : case length in mm  
yyy : case height in mm

zz : 66 660 nm Red  
47 470 nm Blue  
52 525 nm Green  
IR95 950 nm Infrared  
SW White

# QL Series Connections Guide For: QLA-134096-66

## Power Supply Options:

PB-2430	PD2-3024-4
PSB-3024VB	PTU2-3024
PD2-3024	PDS-30
PD2-5024	DIL-5000-WV
PD2-3024-2	STU-3000

- For connection to above listed power supplies, use QADC-01 adaptor cable.
- Extension cables for QLA-134096-66 light when used with above listed power supplies (QADC-01 adaptor required):

FCB-1	FRCB-5	FCB-F-5
FCB-2	FCB-10	FCB-W-2
FCB-3	FCB-20-1.25SQ	FCB-W-5
FCB-5	FCB-F-2	

## 24V DC Connection:

- For direct connection to 24V DC regulated power supply, use QRK-44T-n (n=2,3,5) extension cable.

## QLC-200-24V – Overdriving Strobe Controller:

- For connection to QLC-200-24V controller or direct to 24VDC (QPS-24DC), use QRK-44T-n (n=2,3,5) extension cable.

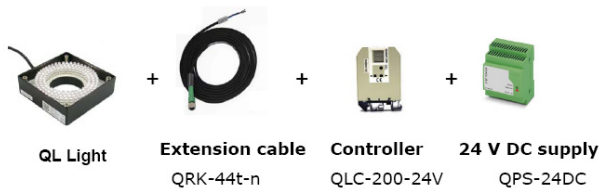

Part Numbers		
Extension Cable	Controller	24 V DC Supply
QRK Series	QLC-200-24V	QPS-24DC

Extension Cable Part numbers	
Part Number	Length (m)
QRK-44T-2	2
QRK-44T-3	3
QRK-44T-5	5

